





11 SERIES: 11.9 K

<http://tiny.cc/11seriesEN>**NEW****C**RUISE
CONTROL

 MAX LIFTING CAPACITY 2620 kg	 ENGINE POWER 75 hp	 SPEED 35 km/h	 FLOW RATE 95 l/min	 LIFT HEIGHT 3,7 m
--	--	---	--	---

**ONE**
DRIVE**ACI**
ATTACHMENT
CONTROL
INTERFACE

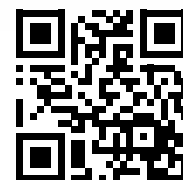
Model	11.9 K STAGE V
Engine	Kohler KDI 2504 - 4 cylinder - 2482 cc
Emission Standard	Stage V
Power (Iso Gross) / Torque	75 HP / 300 Nm @ 1500 rpm
Fuel	Diesel
Transmission	Hydrostatic OneDrive
Drive speed (max.) - 2 speed ⁽¹⁾	17 - 35 km/h (10.5 - 21.5 mph)
Aux. hydraulics oil flow	95 l/min (25 GPM)
Max. lifting height	3,7 m (145.6 in)
Tipping load, max. ⁽²⁾	3280 kg (7231 lbs)
Lifting capacity straight, max. ⁽³⁾	2620 kg (5776 lbs)
Breakout force / 50 cm	3150 kg (6945 lbs)
Pushing force (c)	2650 kgf (2650 kp)
Average ground pressure (w/standard tires)	964 kg/m ² (197 lbs/sqft)
Turning radius: inside/outside	1135/2635 mm (44.7/ 103.7 in)
Standard tires (Tractor profile)	380/55-17
Weight	2400 kg (5291 lbs)
Product Code	C968200

⁽¹⁾ Maximum speed that can be achieved with the largest diameter tires available, on a flat surface and machine without attachments.⁽²⁾ Tipping limit, when the machine is straight, with rear weights and boom lifted just off the ground. Weight of attachment included.⁽³⁾ Maximum load that can be lifted just off the ground when the machine is straight and with rear weights. Weight of attachment is included.

Note: Refer to the Operator's manual for the comprehensive load diagram.

MULTI**ONE**

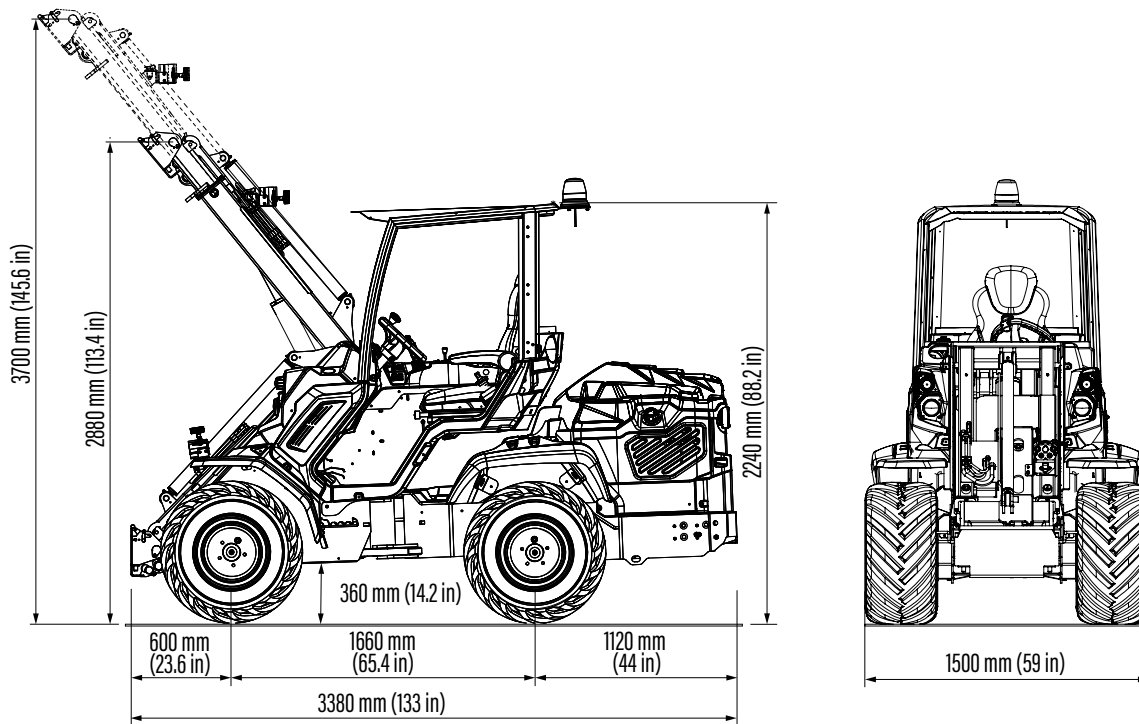

Tires size	Height	Width
380/55-17	2240 mm (88.2 in)	1500 mm (59 in)
400/50-15 (31X15.50-15)	2215 mm (87.2 in)	1500 mm (59 in)

FEATURES

- Kohler KDI2504, 4 cyl., Turbo common rail diesel engine, 2482 cc, water cooled with electric start
- STAGE V
- DPF
- **OneDrive System:** DBS (Dynamic Block System), Cruise Control and Torque Divider activated by Joystick
- ETC - Electronic Throttle Control
- ACI with Multi-functions joystick (22 functions)
- Unbreakable Body Panels
- 2 Speed
- Hydraulically pilot operated variable displacement drive pump
- Hi-Flow system
- Self-locking multi-disk parking brake
- Self-levelling double-H telescopic boom
- Radial Piston high efficiency and heavy duty wheel motors
- 4WD hydrostatic Direct Drive motors, proportional servo control
- Hydraulic oil cooler
- Hydraulic multiconnector
- ROPS-FOPS Level I
- LCD graphic display with programmed service
- 2 front working light
- Fully adjustable suspension heated seat with armrests and seat belt

11 SERIES - OPTIONS

Options	Code
110 V engine block heater	C885255
220 V engine block heater	C885250
2" Hitch receiver (not compatible with C883047)	C883063
3 additional working halogen light	C883064
3 additional working LED light	C883018
A/C system with heating for fully enclosed cab (C883001 required - not aftermarket)	C883902
Additional front hydraulic outlets	C883082
Attachment coupling plate for rear mounting (not compatible with C883037)	C880031
Automatic locking plate	C883008
Backup warning beeper	C883021
Beacon light	C883039
Biodegradable oil	C883032
Driver area cover	C880049
Flat face coupling kit	C880221
Floating boom valve	C883011
Fully enclosed cab with sound insulation linen	C883001
GPS tracker	C883075
Heating system	C883074
Left protection bar for operator	C883020
Mirrors	C880081
OneDrive (OneDrive, DBS, Cruise Control and Torque Divider)	C883811
Polycarbonate back window (smart cabin)	C883035
Polycarbonate right side (smart cabin)	C883034
Polycarbonate windscreen (smart cabin)	C883000
Rear 12V electric socket	C883023
Rear bull bar with side extensions (not compatible with C883063 and C885014)	C883037
Rear hydraulic outlets - double	C883016
Rear hydraulic outlets - single	C883015
Rear weights (440 kg / 970 lbs)	C885025

11 SERIES - OPTIONS

Options	Code
Rear side weights 80 kg (40 kg + 40 kg) / 176 lbs (88 lbs + 88 lbs)	C883069
Rear side weights 160 kg (2x40 kg + 2x40 kg) / 352 lbs (2x88lbs+2x88lbs)	C883077
Rear weights 180 kg (90 kg + 90 kg) / 396 lbs (198lbs + 198 lbs)	C880054
Rubber tracks for 11 series (The kit weights 750 kg / 1655 lbs and increases the height of the machine by 1,5 cm / 0,6 in)	C883107
Snow chains for wheels, 400/50-15 (31x15.50-15), set of 2	C880044
Tie down bracket on wheel hub, set of 4	C883065
Tractor tires 400/50-15 (31x15.50-15), set of 4	C884016
Trailer coupling (not compatible with C883047)	C885017
Turf tires 400/50-15 (31x15.50-15), set of 4	C884013
Turf tires 380/55-17, set of 4	C884017
Warning & Safety lights for road travel (with mirrors)	C883010
Wheel spacer 10 mm (0.4 in), set of 4 (max. 1 pcs for wheel)	C880090
Wheel spacer 55 mm (2.2 in), set of 4 (max. 1 pcs for wheel)	C885010
EU Certificate of Conformity (CoC) for road approval	COC