





1 SERIES: 1.1

<http://tiny.cc/multione1-1EN>

| | | | | |
|---|--|--|--|---|
|  MAX LIFTING CAPACITY 250 kg |  ENGINE POWER 12 hp |  SPEED 8 km/h |  FLOW RATE 19 l/min |  LIFT HEIGHT 1,8 m |
|---|--|--|--|---|

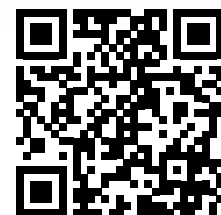

| Model | 1.1 |
|--|-------------------------------------|
| Engine | Yanmar L100 - 1 cylinder - 435cc |
| Emission Standards | Stage V and Tier 4 Final |
| Power (Iso Gross) / Torque | 12 HP / 21 Nm @ 3000 rpm |
| Fuel | Diesel |
| Transmission | Hydrostatic |
| Drive speed (max.) | 8 km/h (5 mph) |
| Aux. hydraulics oil flow | 19 l/min (5 GPM) |
| Max. lifting height | 1,8 m (70.9 in) |
| Tipping load, max. ⁽¹⁾ | 320 kg (705 lbs) |
| Lifting capacity, max. ⁽²⁾ | 250 kg (551 lbs) |
| Breakout force / 50 cm (19.7 in) | 250 kg (551 lbs) |
| Pushing force (c) | 500 kgf (500 kp) |
| Average ground pressure (w/standard tires) | 298 kg/m ² (61 lbs/sqft) |
| Turning radius: inside/outside | 0/993 mm (0/39 in) |
| Standard tires (Tractor profile) | 18x9.50-8 |
| Weight | 398 kg (880 lbs) |
| Product Code | C926006 |

⁽¹⁾ Tipping limit with rear weights and boom lifted just off the ground. Weight of attachment included.⁽²⁾ Maximum load that can be lifted just off the ground. Weight of attachment is included.

Note: Refer to the Operator's manual for the comprehensive load diagram.

MULTI ONE

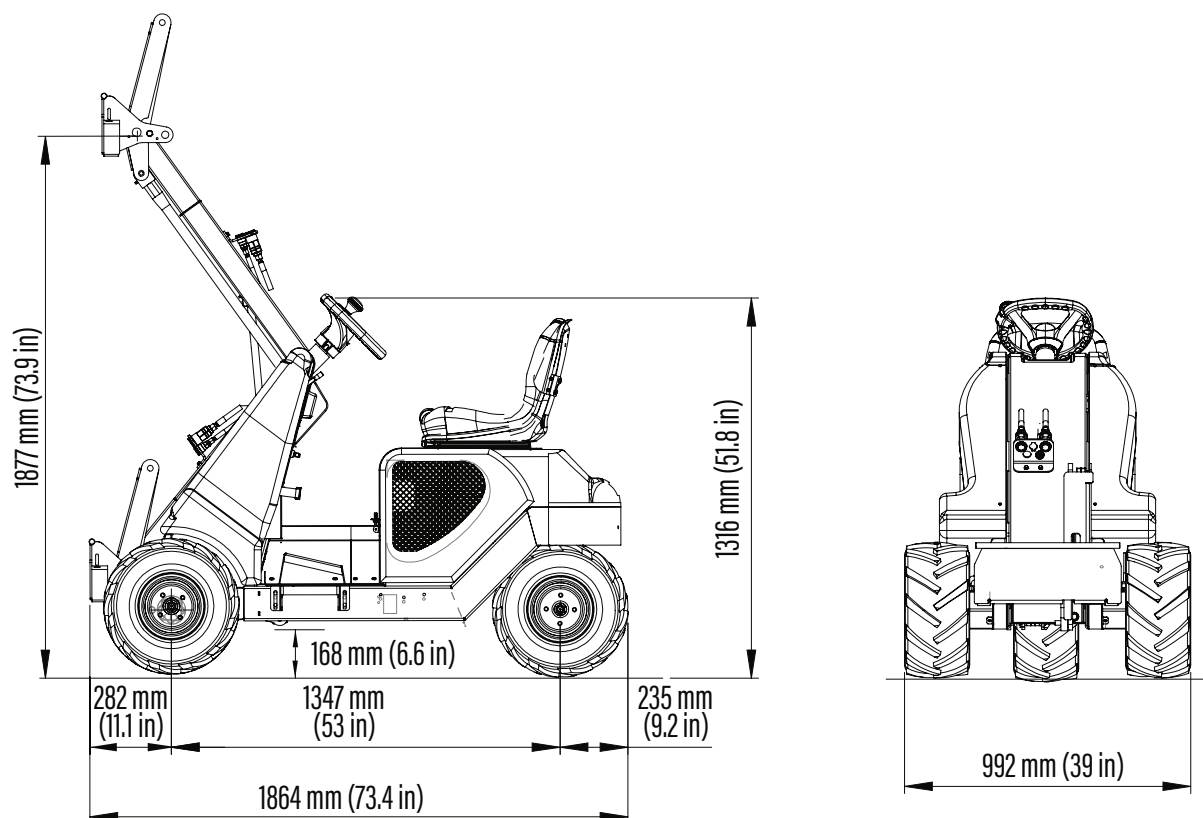

FEATURES

- YANMAR L100 engine, 1 cylinder, diesel engine, 435 cc, air cooled with electric start
- Stage V and Tier 4 Final compliant engine
- 3WD hydrostatic transmission with differential lock
- Variable displacement drive pump
- 3 line hydraulic outlets
- Boom with self-levelling
- 4-functions joystick
- Ergonomic seat with adjustable position
- Mechanical parking brake

| Options | CODE |
|--------------------------------|---------|
| Biodegradable oil | C883059 |
| Gps tracker | C883075 |
| Turf tires 18x9.50-8, set of 3 | C885023 |