

# Gyru-Star 4-120HE



## Carriers

7 - 10 ton Excavators  
 15400 - 22000 lbs Excavators  
 6 - 8 ton loader Lift Capacity  
 13200 - 17600 lbs Loader Lift Capacity

## Weight

560 kg  
 1230 lbs

## Capacity

0.40 m<sup>3</sup>  
 0.52 yd<sup>3</sup>

## Flow

90 l/m  
 24 gpm

## Pressure

200 bar  
 2900 PSI

## Screening Area

615 x 1200 mm    24 x 47 inch

## Dimensions

**A** 615 mm 24 inch    **B** 1200 mm 47 inch  
**C** 570 mm 22 inch    **D** 1550 mm 61 inch  
**E** 820 mm 32 inch    **F** 880 mm 35 inch

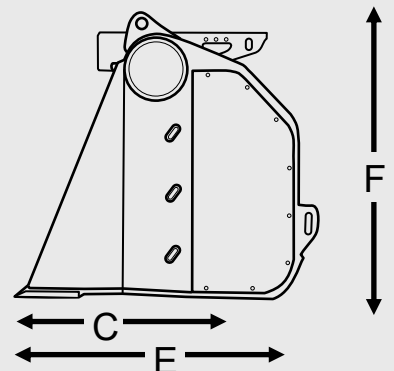
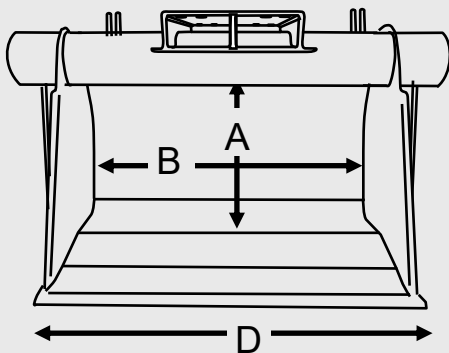

**True compact screening**

**Low maintenance bucket**

**Poly stars which screen without crushing**

**Large screening area to maximise output**

**Non-stick Floor as standard**

***Fast Efficient Screening Systems***